

REACH & RoHS
COMPLIANT

REV.	ECN / DESCRIPTION	BY	DATE
A0	NEW	MQ.Qu	2017.11.29

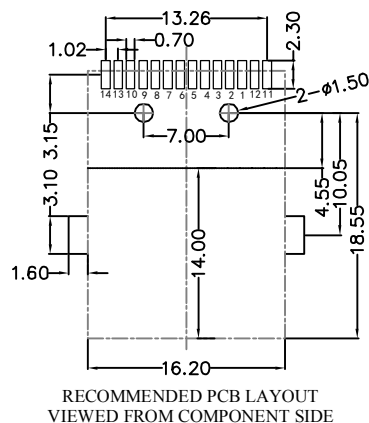
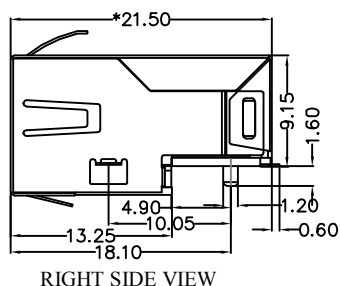
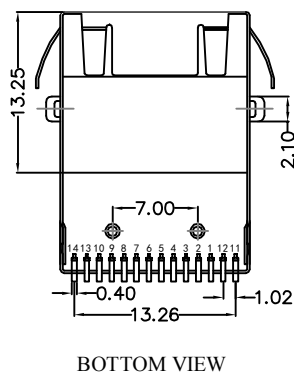
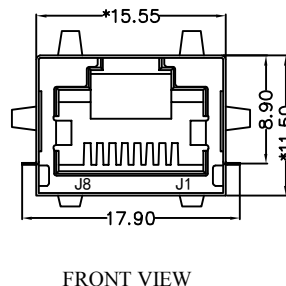
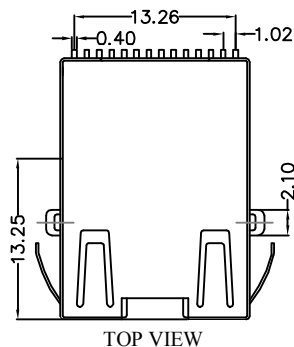

MATERIAL:

HOUSING: LCP,UL94V-0,BLACK.
 TERMINALS BRACKET: LCP,UL94V-0,BLACK.
 SHIELD: C2680,T=0.20MM,NICKEL PLATING ON ALL AREA.
 TERMINAL: PHOSPHOR BRONZE C5210,T=0.35MM,
 6U" GOLD PLATING ON CONTACT AREA.

MECHANICAL:

DURABILITY: 750 CYCLES MIN.
 MATING FORCE: 30N MAX.
 OPERATING TEMPERATURE: -40°C~+85°C.
 STORAGE TEMPERATURE: -40°C~+85°C.
 ALL CRITICAL DIMENSIONS WITH "*"

DGKYD

东莞市科优达电子科技有限公司
 Dong Guan Ke You Da Electronic Tech.Co.,Ltd

ADD: No.1 LiHe Street,LiHeng Village,Qingxi town, DongGuan City,GuangDong Province
 Tel:+86-0769-87334608; Fax:+86-0769-87847129 WWW.DGKYD.COM

TITLE: TAB-UP 1X1 1000BASE 贴片	SIZE A4	UNITS MM[INCH]	GENERAL TOLERANCES UNLESS SPECIFIED		APPROVED BY: JP.Gong
PART NO.: KRJ-CB329WDENL	SACLE 1:1	REV A0	x±0.35	x°±3.0°	CHECKED BY: TW.Xu
REMARK:	SHEET 1/3		.xx±0.25	.xx°±1.5°	DESIGND BY: MQ.Qu
			.xxx±0.10	.xxx°±1.0°	

REACH & RoHS
COMPLIANT

REV.	ECN / DESCRIPTION	BY	DATE
A0	NEW	MQ.Qu	2017.11.29

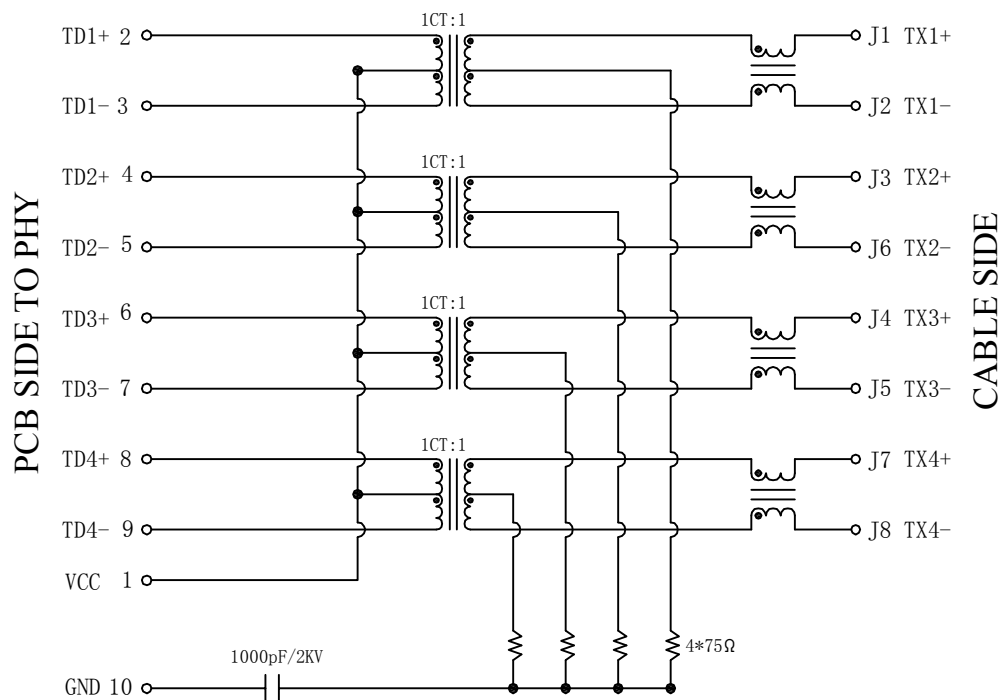

Electrical:

- Turn ratio: 2~3: J1~J2=1CT:1CT(±2%).
4~5: J3~J6=1CT:1CT(±2%).
6~7: J1~J2=1CT:1CT(±2%).
8~9: J3~J6=1CT:1CT(±2%).
- OCL: 350uH Min. at 100KHz 100mV 8mA DC.
- Insertion Loss: -1.0 dB Max 1~100MHz.
- Return loss: -20dB Min 1~10MHz;
-1 6dB Min 10~30MHz.
-1 2dB Min 30~60MHz.
-10dB Min 60~80MHz.
- Cross talk: -40dB Min 1~30MHz;
-35dB Min 30~60MHz;
-30dB Min 60~100MHz;
- CMR: -35dB Min 1~100MHz;
- Hi-Pot: 1500V AC & 2250V DC
6S 1mA PRI TO SEC

DGKYD

东莞市科优达电子科技有限公司
Dong Guan Ke You Da Electronic Tech.Co.,Ltd

ADD: No.1 LiHe Street, LiHeng Village, Qingxi town, DongGuan City, GuangDong Province
Tel: +86-0769-87334608; Fax: +86-0769-87847129 WWW.DGKYD.COM

TITLE: TAB-UP 1X1 1000BASE 贴片	SIZE A4	UNITS MM[INCH]	GENERAL TOLERANCES UNLESS SPECIFIED		APPROVED BY: JP.Gong
PART NO.: KRJ-CB329WDENL	SACLE 1:1	REV A0	x±0.35	x°±3.0°	CHECKED BY: TW.Xu
REMARK:	SHEET 2/3		.xx±0.25	.xx°±1.5°	DESIGND BY: MQ.Qu
			.xxx±0.10	.xxx°±1.0°	

REACH & RoHS
COMPLIANT

REV.	ECN / DESCRIPTION	BY	DATE
A0	NEW	MQ.Qu	2017.11.29

PROFILE OF REFLOW SOLDERING

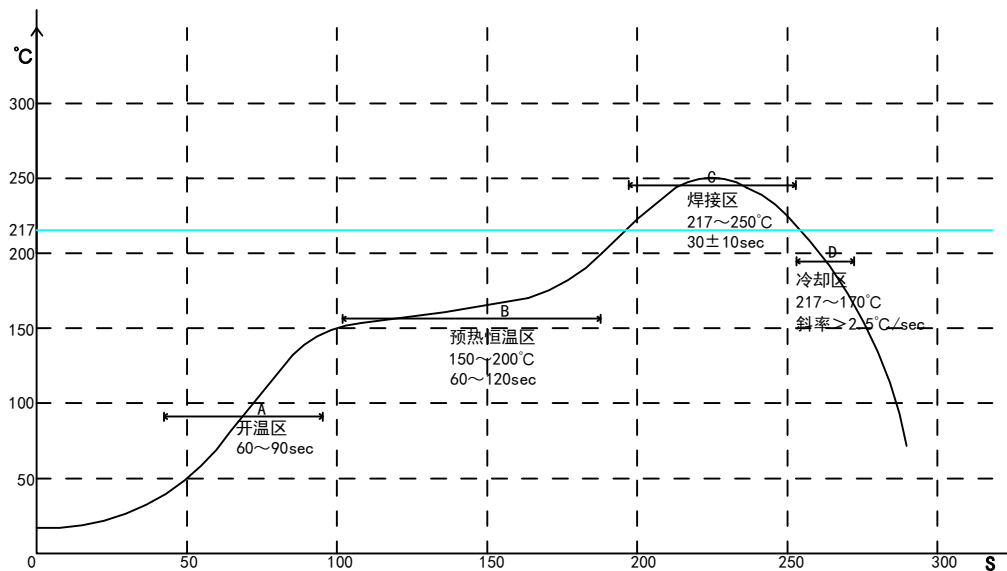

A. Temperature range of open
 B. Preheat temperature zone
 C. The welding zone
 D. The cooling zone
 Tip temperature: 265±5°C.
 Tip temperature time: 30±10Sec.
 Tip melting point of Sn96.5/Ag3/Cu0.5.

DGKYD

东莞市科优达电子科技有限公司
 Dong Guan Ke You Da Electronic Tech.Co.,Ltd

ADD: No.1 LiHe Street, LiHeng Village, Qingxi town, DongGuan City, GuangDong Province
 Tel: +86-0769-87334608; Fax: +86-0769-87847129 WWW.DGKYD.COM

TITLE: TAB-UP 1X1 1000BASE 贴片	SIZE A4	UNITS MM[INCH]	GENERAL TOLERANCES UNLESS SPECIFIED		APPROVED BY: JP.Gong				
			PART NO.: KRJ-CB329WDENL	SACLE 1:1		REV A0	x±0.35	x°±3.0°	CHECKED BY: TW.Xu
							.x±0.30	.x°±2.0°	
							.xx±0.25	.xx°±1.5°	
REMARK:	SHEET 3/3		.xxx±0.10	.xxx°±1.0°	DESIGND BY: MQ.Qu				